



Batterien Knopfzellenbatterie



MN21/23 12V Ø 10 x 27 mm

Art.-Nr.	Bezeichnung	Ref	VP sFr
47.657		<input type="text"/>	7.05

Leclanché



LR1 1.5 V Ø 11.5 x 30 mm

Art.-Nr.	Bezeichnung	Ref	VP sFr
47.650		<input type="text"/>	2.60



LR3 1.5 V Ø 10 x 44 mm

Art.-Nr.	Bezeichnung	Ref	VP sFr
47.651		<input type="text"/>	1.55

Leclanché



LR6 1.5 V Ø 13.5 x 50 mm

Art.-Nr.	Bezeichnung	Ref	VP sFr
47.652		<input type="text"/>	2.00

Leclanché



LR14 1.5 V Ø 24.5 x 49 mm

Art.-Nr.	Bezeichnung	Ref	VP sFr
47.653		<input type="text"/>	3.85

Leclanché



LR20 1.5 V Ø 32.9 x 60 mm

Art.-Nr.	Bezeichnung	Ref	VP sFr
47.654		<input type="text"/>	5.45



VARTA HIGH ENERGY ALKALINE

Art.-Nr.	Bezeichnung	Ref	VP sFr
47.662		<input type="text"/>	7.60

LEVIOR HELMSYSTEME



1.5 V Ø 7.9 x 3.5 mm

LR41

Art.-Nr.	Bezeichnung	Ref	VP sFr
47.59.2.2		<input type="text"/>	3.20



1.5 V Ø 11 x 5 mm

LR44

Art.-Nr.	Bezeichnung	Ref	VP sFr
47.655 47.59.2.1		<input type="text"/>	6.35 1.60

V10GA 319 AG10 LR54 1.5 V



CR1130

Art.-Nr.	Bezeichnung	Ref	VP sFr
47.663		<input type="text"/>	6.40

SR43 1.5V



CR1142

Art.-Nr.	Bezeichnung	Ref	VP sFr
47.665		<input type="text"/>	3.20

3V



CR1232

Art.-Nr.	Bezeichnung	Ref	VP sFr
47.670		<input type="text"/>	10.90



Knopfzellenbatterie + Computer

3V Ø 16 x 1.5 mm



CR1616

Art.-Nr.	Bezeichnung	Ref	VP sFr
47.661		<input type="text"/>	3.80

3 V Ø 16 x 2 mm



CR1620

Art.-Nr.	Bezeichnung	Ref	VP sFr
47.658		<input type="text"/>	4.50

3 V Ø 20 x 2 mm



CR2016

Art.-Nr.	Bezeichnung	Ref	VP sFr
47.659		<input type="text"/>	3.55

3V Ø 20 x 2.9 mm



CR2025

Art.-Nr.	Bezeichnung	Ref	VP sFr
47.660		<input type="text"/>	3.80

3 V Ø 20 x 4.5 mm



CR 2032

Art.-Nr.	Bezeichnung	Ref	VP sFr
47.656		<input type="text"/>	2.75

3V Ø 24 x 3 mm



CR2430

Art.-Nr.	Bezeichnung	Ref	VP sFr
47.664		<input type="text"/>	4.50

3 V Ø 24.5 x 5 mm



CR2450

Art.-Nr.	Bezeichnung	Ref	VP sFr
47.666		<input type="text"/>	4.20

Sigma BC 5.0 WR



Kabel

Art.-Nr.	Ref	VP sFr
47.50	<input type="text"/>	26.40

Sigma BC 5.0 WL ATS



Kabellos

Art.-Nr.	Ref	VP sFr
47.51	<input type="text"/>	47.95

Sigma BC 8.0 WL ATS



Kabellos

Art.-Nr.	Ref	VP sFr
47.52	<input type="text"/>	56.00

Echowell U4



Kabel

Art.-Nr.	Ref	VP sFr
47.90	<input type="text"/>	17.45

Echowell U9



Kabellos

Art.-Nr.	Ref	VP sFr
47.92	<input type="text"/>	23.20



Computer + Körbe Gepäckträger



Kabellos

Art.-Nr.	Bezeichnung	Ref	VP sFr
47.91		<input type="text"/>	36.00



Deluxe

Art.-Nr.	Bezeichnung	Ref	VP sFr
49.22SCH		<input type="text"/>	52.00



Art.-Nr.	Bezeichnung	Ref	VP sFr
49.21SCH		<input type="text"/>	51.20



Art.-Nr.	Bezeichnung	Ref	VP sFr
49.21SI		<input type="text"/>	39.70



Art.-Nr.	Bezeichnung	Ref	VP sFr
49.27		<input type="text"/>	84.00



Art.-Nr.	Bezeichnung	Ref	VP sFr
49.26		<input type="text"/>	40.80



Art.-Nr.	Bezeichnung	Ref	VP sFr
49.28		<input type="text"/>	51.05



Art.-Nr.	Bezeichnung	Ref	VP sFr
49.29		<input type="text"/>	47.85



Art.-Nr.	Bezeichnung	Ref	VP sFr
49.22		<input type="text"/>	23.85



Orion

Art.-Nr.	Bezeichnung	Ref	VP sFr
49.175	silber	<input type="text"/>	69.60
49.176	schwarz	<input type="text"/>	71.70



Athlete

Art.-Nr.	Bezeichnung	Ref	VP sFr
49.160.14	20"	<input type="text"/>	63.20
49.160.15	24"	<input type="text"/>	56.80
49.160SCH	26-28"	<input type="text"/>	52.00

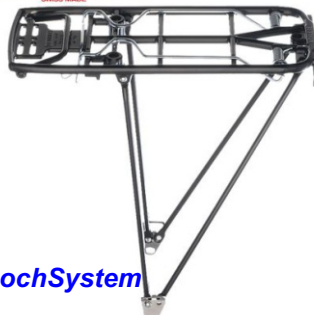

Athlete

3 LochSystem

Art.-Nr.	Bezeichnung	Ref	VP sFr
49.160.0	26-28"	<input type="text"/>	57.45
49.160.29	29"	<input type="text"/>	51.20



Gepäckträger

PLETSCHER SWISS MADE **Athlete**

3-LS=3 LochSystem

Art.-Nr.	Bezeichnung	Ref	VP sFr
49.160.10		<input type="text"/>	56.80
49.160.12	3-LS	<input type="text"/>	79.95

PLETSCHER SWISS MADE **Mercur**

3 LochSystem

Art.-Nr.	Bezeichnung	Ref	VP sFr
49.165SCH		<input type="text"/>	67.20

PLETSCHER SWISS MADE **Prisma**

3 LochSystem

Art.-Nr.	Bezeichnung	Ref	VP sFr
49.160.00		<input type="text"/>	63.85

PLETSCHER SWISS MADE **Apollo**

Art.-Nr.	Bezeichnung	Ref	VP sFr
49.161		<input type="text"/>	95.70

PLETSCHER SWISS MADE **Wersa**

Art.-Nr.	Bezeichnung	Ref	VP sFr
49.166SCH		<input type="text"/>	61.60

PLETSCHER SWISS MADE **Inova**

A

Art.-Nr.	Bezeichnung	Ref	VP sFr
49.180SCH	26-28"	<input type="text"/>	60.00
49.180.1	A	<input type="text"/>	11.05

PLETSCHER SWISS MADE

Art.-Nr.	Bezeichnung	Ref	VP sFr
49.172	18"	<input type="text"/>	25.60
49.172.1	20"	<input type="text"/>	26.60
49.172.2	22"	<input type="text"/>	25.60
49.172.3	24"	<input type="text"/>	30.10
49.172.4	26"	<input type="text"/>	25.60
49.172.5	28"	<input type="text"/>	36.65

PLETSCHER SWISS MADE **Wersa**

Art.-Nr.	Ref	VP sFr
49.166.1	<input type="text"/>	33.45

PLETSCHER SWISS MADE

Art.-Nr.	Ref	VP sFr
49.160.30	148	<input type="text"/> 6.10
49.160.31	178	<input type="text"/> 7.20

PLETSCHER SWISS MADE

Art.-Nr.	Ref	VP sFr
49.160.1	120	<input type="text"/> 4.00

PLETSCHER SWISS MADE

Art.-Nr.	Ref	VP sFr
49.160.2	145	<input type="text"/> 5.60
49.160.19	160	<input type="text"/> 7.05
49.160.20	205	<input type="text"/> 7.85

PLETSCHER SWISS MADE

Art.-Nr.	Ref	VP sFr
49.160.3	115	<input type="text"/> 4.50
49.160.25	145	<input type="text"/> 7.70
49.160.25SCH	145	<input type="text"/> 8.40



Gepäckträgererteile



PLETSCHER
SWISS MADE

A=66/85
B=66/230

Art.-Nr.	Bezeichnung	Ref	VP sFr
49.161.3	A	<input type="text"/>	7.95
49.161.4	B	<input type="text"/>	12.65

PLETSCHER
SWISS MADE

A=66/130
B=66/185
C=66/230

Art.-Nr.	Bezeichnung	Ref	VP sFr
49.161.2	A	<input type="text"/>	9.00
49.161.1	B	<input type="text"/>	9.15
49.161.5	C	<input type="text"/>	11.70

PLETSCHER
SWISS MADE

Art.-Nr.	Bezeichnung	Ref	VP sFr
49.160.10.1		<input type="text"/>	31.20

PLETSCHER
SWISS MADE

Art.-Nr.	Bezeichnung	Ref	VP sFr
49.160.9.1		<input type="text"/>	5.60

PLETSCHER
SWISS MADE

A

Art.-Nr.	Bezeichnung	Ref	VP sFr
49.160.9		<input type="text"/>	3.70
49.160.8	A	<input type="text"/>	0.50

PLETSCHER
SWISS MADE

Art.-Nr.	Bezeichnung	Ref	VP sFr
49.160.11		<input type="text"/>	7.70

PLETSCHER
SWISS MADE

Art.-Nr.	Bezeichnung	Ref	VP sFr
49.22.2		<input type="text"/>	2.70

PLETSCHER
SWISS MADE

Art.-Nr.	Bezeichnung	Ref	VP sFr
49.160.0.5		<input type="text"/>	2.70

PLETSCHER
SWISS MADE

Art.-Nr.	Bezeichnung	Ref	VP sFr
49.160.5.1		<input type="text"/>	9.50

PLETSCHER
SWISS MADE

Art.-Nr.	Bezeichnung	Ref	VP sFr
49.160.5		<input type="text"/>	4.50

PLETSCHER
SWISS MADE

Art.-Nr.	Bezeichnung	Ref	VP sFr
49.170		<input type="text"/>	4.50

PLETSCHER
SWISS MADE

Art.-Nr.	Bezeichnung	Ref	VP sFr
50.531		<input type="text"/>	66.40



Gepäckträgerteile Sitzli Riemen



PLETSCHER
SWISS MADE



Art.-Nr. **49.160.0.2** Bezeichnung Ref VP sFr **63.85**

PLETSCHER
SWISS MADE



Art.-Nr. **49.160.0.1** Bezeichnung Ref VP sFr **31.20**

PLETSCHER
SWISS MADE



Art.-Nr. **49.160.4.1** Bezeichnung Ref VP sFr **2.65**



Art.-Nr. **64.23.3** Bezeichnung Ref VP sFr **3.85**



Art.-Nr. **49.85** Bezeichnung Ref VP sFr **11.05**



600mm

Art.-Nr. **49.97** Bezeichnung Ref VP sFr **3.60**



800mm

Art.-Nr. **49.98** Bezeichnung Ref VP sFr **4.00**



1000mm

Art.-Nr. **49.99** Bezeichnung Ref VP sFr **4.00**



Art.-Nr. **49.100** Bezeichnung Ref VP sFr **3.60**

Polisport
Wallaby



3 LochSystem

Art.-Nr. **50.530** Bezeichnung Ref VP sFr **238.00**

PLETSCHER
SWISS MADE



3 LochSystem

Art.-Nr. **49.35** **12L** Bezeichnung Ref VP sFr **86.40**

POINT



10L

Art.-Nr. **49.30** **10L** Bezeichnung Ref VP sFr **104.00**



Körbe Gepäckträger Taschen **racktime**

racktime 2.0



Art.-Nr. Bezeichnung Ref VP sFr
49.189SCH **74.40**

racktime 2.0



Art.-Nr. Bezeichnung Ref VP sFr
49.194SCH **120.00**

racktime 2.0

A=large
B=small



Art.-Nr. Bezeichnung Ref VP sFr
49.311213.2.0 A **58.40**
49.311220.2.0 B **60.65**

racktime 2.0



Art.-Nr. Bezeichnung Ref VP sFr
49.311632 **28.65**

racktime 2.0



Art.-Nr. Bezeichnung Ref VP sFr
49.311633 **28.65**

racktime



Art.-Nr. Bezeichnung Ref VP sFr
49.311242 **104.00**

racktime schwarz

A=large
B=small

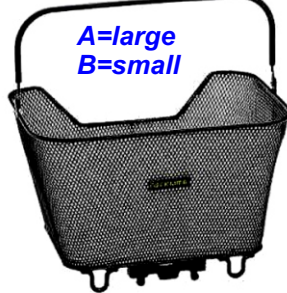

Art.-Nr. Bezeichnung Ref VP sFr
49.311213 A **58.40**
49.311220 B **58.40**

racktime silber

A=large
B=small



Art.-Nr. Bezeichnung Ref VP sFr
49.311214 A **57.60**
49.311221 B **54.40**

racktime weiss

A=large
B=small



Art.-Nr. Bezeichnung Ref VP sFr
49.311277 A **54.40**

racktime



Small

Art.-Nr. Bezeichnung Ref VP sFr
49.311239 **63.95**

racktime



Art.-Nr. Bezeichnung Ref VP sFr
49.311575 **78.80**

racktime



Art.-Nr. Bezeichnung Ref VP sFr
49.311594 **113.60**



Gepäckträger + Ersatzteile **racktime**

racktime



Art.-Nr.	Bezeichnung	Ref	VP sFr
49.193		<input type="text"/>	69.60

racktime



Art.-Nr.	Bezeichnung	Ref	VP sFr
49.191SCH		<input type="text"/>	77.60

racktime



Art.-Nr.	Bezeichnung	Ref	VP sFr
49.190SCH		<input type="text"/>	62.25

racktime



Art.-Nr.	Bezeichnung	Ref	VP sFr
49.193SCH		<input type="text"/>	127.20

racktime



Art.-Nr.	Bezeichnung	Ref	VP sFr
49.192SCH		<input type="text"/>	140.80

racktime



Art.-Nr.	Bezeichnung	Ref	VP sFr
49.195SCH		<input type="text"/>	73.60

racktime



schwarz
silber

Art.-Nr.	Bezeichnung	Ref	VP sFr
49.311229	8.5/Ø10	<input type="text"/>	19.05
49.311231	10/Ø12	<input type="text"/>	19.05
49.311228	11/Ø10	<input type="text"/>	19.05
49.311251	11/Ø10	<input type="text"/>	18.80

racktime



Art.-Nr.	Ref	VP sFr
49.311230	<input type="text"/>	4.65

racktime



Art.-Nr.	Ref	VP sFr
49.311215	<input type="text"/>	31.95

racktime



Art.-Nr.	Ref	VP sFr
49.311219	<input type="text"/>	20.00

racktime



Art.-Nr.	Ref	VP sFr
49.190.1	<input type="text"/>	23.20

racktime

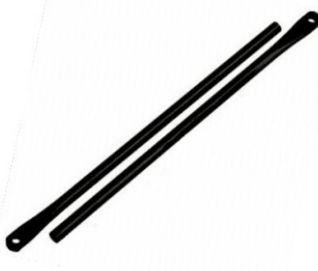

Art.-Nr.	Ref	VP sFr
49.190.3	<input type="text"/>	6.90



Gepäckträger + Ersatzteile **racktime** Halter **KLICKfix**

racktime

Art.-Nr.	Bezeichnung	Ref	VP sFr
49.190.2		<input type="text"/>	10.40

racktime

120 mm

e-bike geeignet

Art.-Nr.	Bezeichnung	Ref	VP sFr
61.180		<input type="text"/>	33.45

racktime

125 mm

e-bike geeignet

Art.-Nr.	Bezeichnung	Ref	VP sFr
61.181		<input type="text"/>	62.40

Carrymore I + II

Art.-Nr.	Bezeichnung	Ref	VP sFr
49.311900		<input type="text"/>	22.45

Carrymore I + II

Art.-Nr.	Bezeichnung	Ref	VP sFr
49.311905		<input type="text"/>	47.85

KLICKfix

Art.-Nr.	Bezeichnung	Ref	VP sFr
49.20	Ø 22.2	<input type="text"/>	25.30
49.20.1	Ø 22.2-31.8	<input type="text"/>	36.00

KLICKfix

BOSCH

e-bike geeignet

Art.-Nr.	Bezeichnung	Ref	VP sFr
49.20.14		<input type="text"/>	50.40

KLICKfix

BOSCH

e-bike geeignet

Art.-Nr.	Bezeichnung	Ref	VP sFr
49.20.15		<input type="text"/>	40.80

KLICKfix

Art.-Nr.	Bezeichnung	Ref	VP sFr
49.20.6		<input type="text"/>	2.10

KLICKfix

Art.-Nr.	Bezeichnung	Ref	VP sFr
49.20.10		<input type="text"/>	12.00

KLICKfix

Art.-Nr.	Bezeichnung	Ref	VP sFr
49.20.5	Ø 31.8	<input type="text"/>	9.45
49.20.7	Ø 35.0	<input type="text"/>	5.80

KLICKfix

Art.-Nr.	Bezeichnung	Ref	VP sFr
49.20.16		<input type="text"/>	13.60



Körbe Halter **KLICKfix**

KLICKfix



Art.-Nr.	Bezeichnung	Ref	VP sFr
49.20.1SCH	schwarz	<input type="text"/>	20.65
49.20.1W	weiss	<input type="text"/>	20.65

KLICKfix 31x21x19cm



Art.-Nr.	Bezeichnung	Ref	VP sFr
49.19		<input type="text"/>	39.85

34x25x26cm **KLICKfix**



Art.-Nr.	Bezeichnung	Ref	VP sFr
49.20.2SCH	schwarz	<input type="text"/>	44.65
49.20.2SI	silber	<input type="text"/>	26.40

KLICKfix

A=34x23x20cm
B=35x26x25cm



Art.-Nr.	Bezeichnung	Ref	VP sFr
49.33	A	<input type="text"/>	91.05
49.32	B	<input type="text"/>	90.40

KLICKfix



Art.-Nr.	Bezeichnung	Ref	VP sFr
49.44		<input type="text"/>	233.60

KLICKfix



Art.-Nr.	Bezeichnung	Ref	VP sFr
49.20.4		<input type="text"/>	102.40

KLICKfix



Art.-Nr.	Bezeichnung	Ref	VP sFr
49.20.3SCH		<input type="text"/>	63.85

KLICKfix



Art.-Nr.	Bezeichnung	Ref	VP sFr
49.20.8SCH		<input type="text"/>	64.80

KLICKfix



Art.-Nr.	Bezeichnung	Ref	VP sFr
49.800		<input type="text"/>	164.80

KLICKfix



Art.-Nr.	Bezeichnung	Ref	VP sFr
49.810		<input type="text"/>	47.20

KLICKfix



Art.-Nr.	Bezeichnung	Ref	VP sFr
100.1153		<input type="text"/>	57.60

KLICKfix



Art.-Nr.	Bezeichnung	Ref	VP sFr
49.850		<input type="text"/>	136.00



Gepäckträgererteile THULE



atran^{velo}
CYCLELAB

BASIL®

THULE Tour Rack



für Fullys

Art.-Nr.	Bezeichnung	Ref	VP sFr
49.200		<input type="text"/>	127.70

THULE



Art.-Nr.	Bezeichnung	Ref	VP sFr
49.205		<input type="text"/>	46.25

THULE



Art.-Nr.	Bezeichnung	Ref	VP sFr
49.210		<input type="text"/>	120.00

around



Art.-Nr.	Bezeichnung	Ref	VP sFr
100.BA17306		<input type="text"/>	63.20



Art.-Nr.	Bezeichnung	Ref	VP sFr
49.159		<input type="text"/>	54.40



Art.-Nr.	Bezeichnung	Ref	VP sFr
49.50		<input type="text"/>	47.20

atran^{velo}
CYCLELAB



Art.-Nr.	Bezeichnung	Ref	VP sFr
49.152	16L	<input type="text"/>	47.20
49.151	22L	<input type="text"/>	47.95

atran^{velo}
CYCLELAB



Art.-Nr.	Ref	VP sFr
49.150	<input type="text"/>	52.80

atran^{velo}
CYCLELAB



Art.-Nr.	Ref	VP sFr
49.155	<input type="text"/>	23.20

BASIL®
30x43x23 cm



Base M MIK

Art.-Nr.	Ref	VP sFr
49.140	<input type="text"/>	58.40

BASIL®
32x41.5x27 cm



Lesto MIK

Art.-Nr.	Ref	VP sFr
49.142	<input type="text"/>	63.20

MIK



Art.-Nr.	Ref	VP sFr
49.144	<input type="text"/>	31.85



Körbe + Regenschutz

BASIL



MIK

Art.-Nr.	Bezeichnung	Ref	VP sFr
49.143		<input type="text"/>	28.65

A=40 x 30 x 15 cm
B=49 x 29 x 19 cm



Art.-Nr.	Bezeichnung	Ref	VP sFr
49.21.1SCH	A	<input type="text"/>	21.60
49.21.2SCH	B	<input type="text"/>	25.45

A=40 x 29 x 18 cm
B=48 x 30 x 20 cm

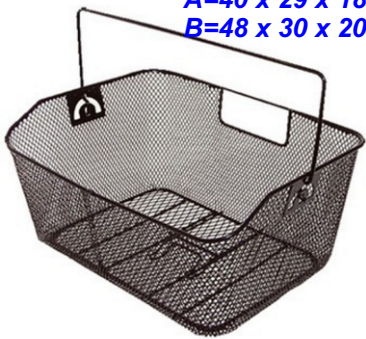

Art.-Nr.	Bezeichnung	Ref	VP sFr
49.21.3SCH	A	<input type="text"/>	20.00
49.21.4SCH	B	<input type="text"/>	24.80

40 x 29 x 18 cm



Halter verstellbar

Art.-Nr.	Bezeichnung	Ref	VP sFr
49.21.6SCH		<input type="text"/>	18.40

40 x 30 x 18 mm



Klemmbefestigung

Art.-Nr.	Bezeichnung	Ref	VP sFr
49.23		<input type="text"/>	23.20

40 x 29 x 18 cm



Art.-Nr.	Bezeichnung	Ref	VP sFr
49.45		<input type="text"/>	60.80

klappbar



Art.-Nr.	Bezeichnung	Ref	VP sFr
49.24		<input type="text"/>	30.25

klappbar



Art.-Nr.	Bezeichnung	Ref	VP sFr
46.25		<input type="text"/>	34.40



Art.-Nr.	Bezeichnung	Ref	VP sFr
49.20.20		<input type="text"/>	7.70



Art.-Nr.	Bezeichnung	Ref	VP sFr
49.20.30		<input type="text"/>	9.30

40 x 30 cm



Regenschutz

Art.-Nr.	Bezeichnung	Ref	VP sFr
31.20		<input type="text"/>	14.50

Haberland 50 x 40 cm



Art.-Nr.	Bezeichnung	Ref	VP sFr
31.25		<input type="text"/>	14.35



Helme Cratoni

Gr. 53-59



CRATONI

AllRide Junior

Art.-Nr. Bezeichnung Ref VP sFr

50.400 56.00

Gr. 53-59



CRATONI

AllRide Junior

Art.-Nr. Bezeichnung Ref VP sFr

50.401 56.00

Gr. 53-59



CRATONI

AllRide Junior

Art.-Nr. Bezeichnung Ref VP sFr

50.402 56.00

Gr. 58-62



CRATONI

Pacer

Art.-Nr. Bezeichnung Ref VP sFr

50.410 79.85

Gr. 58-62



CRATONI

Pacer

Art.-Nr. Bezeichnung Ref VP sFr

50.412 79.85

Gr. 58-62



CRATONI

Pacer

Art.-Nr. Bezeichnung Ref VP sFr

50.414 79.85

Gr. 58-62



CRATONI

Pacer

Art.-Nr. Bezeichnung Ref VP sFr

50.416 79.85

Gr. 58-62



CRATONI

Pacer

Art.-Nr. Bezeichnung Ref VP sFr

50.418 79.85

Gr. 54-58



CRATONI

Pacer Junior

Art.-Nr. Bezeichnung Ref VP sFr

50.420 63.85

Gr. 54-58



CRATONI

Pacer Junior

Art.-Nr. Bezeichnung Ref VP sFr

50.422 63.85

Gr. 54-58



CRATONI

Pacer Junior

Art.-Nr. Bezeichnung Ref VP sFr

50.424 63.85

Gr. 54-58



CRATONI

Pacer Junior

Art.-Nr. Bezeichnung Ref VP sFr

50.426 63.85



Helme Levior

LEVIOR
HELMSYSTEME

Primo



Grösse 46-51 cm
Gewicht 250 g

Art.-Nr.	Bezeichnung	Ref	VP sFr
50.262		<input type="text"/>	47.85

LEVIOR
HELMSYSTEME

Primo



Grösse 46-51 cm
Gewicht 250 g

Art.-Nr.	Bezeichnung	Ref	VP sFr
50.263		<input type="text"/>	43.20

LEVIOR
HELMSYSTEME

NEU



Grösse S 46-51 cm + M 52-58 cm

Art.-Nr.	Bezeichnung	Ref	VP sFr
50.272	46-51	<input type="text"/>	52.80

LEVIOR
HELMSYSTEME



Grösse 46-51 cm + 52-58 cm

Art.-Nr.	Bezeichnung	Ref	VP sFr
50.350	46-51	<input type="text"/>	56.00
50.351	52-58	<input type="text"/>	56.00

LEVIOR
HELMSYSTEME

Primo Lizenz



Grösse 46-51 cm + 52-58 cm
Gewicht 250 g

Art.-Nr.	Bezeichnung	Ref	VP sFr
50.276	46-51	<input type="text"/>	56.00

LEVIOR
HELMSYSTEME

Primo



Grösse 46-51 cm + 52-58 cm
Gewicht 250 - 280 g

Art.-Nr.	Bezeichnung	Ref	VP sFr
50.305	46-51	<input type="text"/>	45.60
50.306	52-58	<input type="text"/>	45.60

LEVIOR
HELMSYSTEME

Primo



Grösse 46-51 cm + 52-58 cm
Gewicht 250 - 280 g

Art.-Nr.	Bezeichnung	Ref	VP sFr
50.308	46-51	<input type="text"/>	45.60
50.309	52-58	<input type="text"/>	45.60

LEVIOR
HELMSYSTEME

Kailu



Grösse 53-59 cm
Gewicht 260 g

Art.-Nr.	Ref	VP sFr
50.290	<input type="text"/>	66.60

LEVIOR
HELMSYSTEME

Sparky



Grösse 53-58 cm
Gewicht 280 g

Art.-Nr.	Ref	VP sFr
50.251	<input type="text"/>	54.40

LEVIOR
HELMSYSTEME

Sparky



Grösse 53-58 cm
Gewicht 280 g

Art.-Nr.	Ref	VP sFr
50.252	<input type="text"/>	54.40

LEVIOR
HELMSYSTEME

Sparky



Grösse 53-58 cm
Gewicht 280 g

Art.-Nr.	Ref	VP sFr
50.253	<input type="text"/>	54.40

LEVIOR
HELMSYSTEME

Pina



Grösse 52-56 cm
Gewicht 340 g

Art.-Nr.	Ref	VP sFr
50.288	<input type="text"/>	72.00



Helme Levior

LEVIOR
HELMSYSTEME

Freeride Triger



Grösse 54-57 cm

Art.-Nr.	Bezeichnung	Ref	VP sFr
50.279		<input type="text"/>	73.60

LEVIOR
HELMSYSTEME

SKY



Grösse 60-64 cm

Art.-Nr.	Bezeichnung	Ref	VP sFr
50.240	schwarz	<input type="text"/>	78.40
50.241	weiss	<input type="text"/>	78.40

LEVIOR
HELMSYSTEME

Spiri Two



Grösse 52-58 cm + 55-61 cm
Gewicht 290 g

Art.-Nr.	Bezeichnung	Ref	VP sFr
50.331	55-61	<input type="text"/>	76.80

LEVIOR
HELMSYSTEME

Flitzi



Grösse 55-61 cm
Gewicht 280 g

Art.-Nr.	Bezeichnung	Ref	VP sFr
50.213	52-57	<input type="text"/>	44.80

LEVIOR
HELMSYSTEME

Joker



Grösse 57-62 cm

Art.-Nr.	Bezeichnung	Ref	VP sFr
50.237	52-58	<input type="text"/>	46.40

LEVIOR
HELMSYSTEME

Flitzi



Grösse 52-57 cm + 56-61 cm
Gewicht 280 g

Art.-Nr.	Bezeichnung	Ref	VP sFr
50.202	52-57	<input type="text"/>	44.80

LEVIOR
HELMSYSTEME

Opus Visor



Grösse 52-58 cm + 56-62 cm
Gewicht 310 g

Art.-Nr.	Bezeichnung	Ref	VP sFr
50.254	52-58	<input type="text"/>	65.60

LEVIOR
HELMSYSTEME

Opus Visor



Grösse 52-58 cm + 56-62 cm
Gewicht 310 g

Art.-Nr.	Bezeichnung	Ref	VP sFr
50.256	52-58	<input type="text"/>	67.20
50.257	56-62	<input type="text"/>	67.20

LEVIOR
HELMSYSTEME

Opus Visor



Grösse 52-58 cm + 56-62 cm
Gewicht 310 g

Art.-Nr.	Bezeichnung	Ref	VP sFr
50.258	52-58	<input type="text"/>	67.20

LEVIOR
HELMSYSTEME



Clip-Steckschloss

Art.-Nr.	Ref	VP sFr
50.281.2.0	<input type="text"/>	3.55

LEVIOR
HELMSYSTEME



Gurtstraffer

Art.-Nr.	Ref	VP sFr
50.281.3	<input type="text"/>	5.95

LEVIOR
HELMSYSTEME

Sparki Primo Sport



Visier

Art.-Nr.	Ref	VP sFr
50.280.1	<input type="text"/>	9.55



Helme Levior Sonnenbrillen Kindersitze

LEVIOR
HELMSYSTEME

Spiri Two



Visier

Art.-Nr.	Bezeichnung	Ref	VP sFr
50.280.7		<input type="text"/>	12.00

LEVIOR
HELMSYSTEME



LR41

Art.-Nr.	Bezeichnung	Ref	VP sFr
47.59.2.2		<input type="text"/>	3.20

POINT



Art.-Nr.	Bezeichnung	Ref	VP sFr
50.103		<input type="text"/>	24.80

POINT



Art.-Nr.	Bezeichnung	Ref	VP sFr
50.106		<input type="text"/>	31.20

POINT



Art.-Nr.	Bezeichnung	Ref	VP sFr
50.108		<input type="text"/>	47.85

POINT



Art.-Nr.	Bezeichnung	Ref	VP sFr
50.109		<input type="text"/>	47.85

POINT



Art.-Nr.	Bezeichnung	Ref	VP sFr
50.111		<input type="text"/>	47.85

Helm Regenschutz



mit Reflektoren

Art.-Nr.	Bezeichnung	Ref	VP sFr
31.8.1		<input type="text"/>	13.15

Helm Regenschutz



mit Reflektoren

Art.-Nr.	Bezeichnung	Ref	VP sFr
31.8		<input type="text"/>	11.30

Helm Mütze



onesize

Art.-Nr.	Bezeichnung	Ref	VP sFr
31.8.2		<input type="text"/>	12.00

BABY



Art.-Nr.	Bezeichnung	Ref	VP sFr
50.702		<input type="text"/>	31.85

BABY



Art.-Nr.	Bezeichnung	Ref	VP sFr
50.720.6		<input type="text"/>	22.40



Kindersitze + Teile **BABY**

10+ **BABY**

Art.-Nr. **50.730** Bezeichnung Ref VP sFr **126.40**

10+ **BABY**

Art.-Nr. **50.732** Bezeichnung Ref VP sFr **126.40**

Sirius Ercon 10+ Shield **BABY**

Standard

Art.-Nr. **50.7110** Bezeichnung Ref VP sFr **13.60**

Sirius Ercon 10+ Shield **BABY**

für kleine Rahmen

Art.-Nr. **50.7111** Bezeichnung Ref VP sFr **13.60**

Sirius Ercon 10+ Shield **BABY**

Neigung nach hinten

Art.-Nr. **50.7112** Bezeichnung Ref VP sFr **13.60**

Sirius Ercon 10+ Shield **BABY**

Neigung nach vorne

Art.-Nr. **50.7113** Bezeichnung Ref VP sFr **13.60**

Sirius Ercon 10+ Shield **BABY**

Art.-Nr. **50.712** Bezeichnung Ref VP sFr **24.00**

Shield **BABY**

Art.-Nr. **50.750** Bezeichnung Ref VP sFr **93.60**

Shield **BABY**

Art.-Nr. **50.750.1** Bezeichnung Ref VP sFr **44.00**

Orion **BABY**

Art.-Nr. **50.701.53** Bezeichnung Ref VP sFr **92.80**

Orion **BABY**

Art.-Nr. **50.707** Bezeichnung Ref VP sFr **22.40**

Polisport Wallaby

Art.-Nr. **50.530** Bezeichnung Ref VP sFr **238.40**



Kindersitze + Teile Seitenständer Seitenstütze



Polisport Wallaby



Art.-Nr.	Bezeichnung	Ref	VP sFr
50.550		<input type="text"/>	143.20

Polisport Wallaby



Art.-Nr.	Bezeichnung	Ref	VP sFr
50.740		<input type="text"/>	36.80

Polisport Guppy Maxi



Gepäckträger montage

Art.-Nr.	Bezeichnung	Ref	VP sFr
50.555		<input type="text"/>	143.20

Restbestand



Art.-Nr.	Bezeichnung	Ref	VP sFr
50.805		<input type="text"/>	102.40

PLETSCHER SWISS MADE



Art.-Nr.	Bezeichnung	Ref	VP sFr
51.15	silber	<input type="text"/>	13.15
51.15SCH	schwarz	<input type="text"/>	15.85

PLETSCHER SWISS MADE



Art.-Nr.	Bezeichnung	Ref	VP sFr
51.16.5		<input type="text"/>	4.00

PLETSCHER SWISS MADE



Art.-Nr.	Bezeichnung	Ref	VP sFr
51.16.6		<input type="text"/>	2.90

PLETSCHER SWISS MADE



Art.-Nr.	Bezeichnung	Ref	VP sFr
51.16		<input type="text"/>	12.20

PLETSCHER SWISS MADE



Art.-Nr.	Bezeichnung	Ref	VP sFr
51.26		<input type="text"/>	47.85

PLETSCHER SWISS MADE



18mm

Art.-Nr.	Bezeichnung	Ref	VP sFr
51.18.52		<input type="text"/>	25.45

PLETSCHER SWISS MADE



18mm

Art.-Nr.	Bezeichnung	Ref	VP sFr
51.18.56		<input type="text"/>	30.25

PLETSCHER SWISS MADE



23 mm

Art.-Nr.	Bezeichnung	Ref	VP sFr
51.18.67		<input type="text"/>	30.25



Seitenstützen / Seitenständer



PLETSCHER
SWISS MADE



Art.-Nr. **51.18.61** Bezeichnung Ref VP sFr **20.65**

PLETSCHER
SWISS MADE



Art.-Nr. **51.18.62** Bezeichnung Ref VP sFr **20.65**

PLETSCHER
SWISS MADE



Art.-Nr. **51.18.51** Bezeichnung Ref VP sFr **31.85**

PLETSCHER
SWISS MADE



Art.-Nr. **51.18.54** Bezeichnung Ref VP sFr **31.20**

PLETSCHER
SWISS MADE



Art.-Nr. **51.18.49** Bezeichnung Ref VP sFr **33.45**

PLETSCHER
SWISS MADE



Art.-Nr. **51.114** Bezeichnung Ref VP sFr **2.00**

atran velo
cycleLAB



Art.-Nr. **51.18.82** Bezeichnung Ref VP sFr **14.75**

atran velo
cycleLAB



Art.-Nr. **51.18.72** Bezeichnung Ref VP sFr **23.85**

atran velo
cycleLAB



Art.-Nr. **51.18.74** Bezeichnung Ref VP sFr **25.45**

atran velo
cycleLAB



Art.-Nr. **51.18.76** Bezeichnung Ref VP sFr **24.80**

atran velo
cycleLAB



Art.-Nr. **51.18.75** Bezeichnung Ref VP sFr **18.40**

atran velo
cycleLAB



Art.-Nr. **51.18.80** Bezeichnung Ref VP sFr **20.80**



Seitenstützen / Seitenständer



Art.-Nr. **51.19** Bezeichnung Ref VP sFr **30.40**



Art.-Nr. **51.28** Bezeichnung Ref VP sFr **43.20**



Art.-Nr. **51.18.55** Bezeichnung **26-28"** Ref VP sFr **31.85**
51.18.550 **29"** Ref VP sFr **36.65**



Art.-Nr. **51.18.70** Bezeichnung Ref VP sFr **33.45**



Art.-Nr. **51.18.71** Bezeichnung Ref VP sFr **63.85**



Art.-Nr. **51.18.99** Bezeichnung Ref VP sFr **78.40**



Art.-Nr. **51.116** Bezeichnung Ref VP sFr **2.40**



Art.-Nr. **51.18.90** Bezeichnung Ref VP sFr **23.85**



Art.-Nr. **51.25** Bezeichnung Ref VP sFr **52.80**



Art.-Nr. **51.18.85** Bezeichnung Ref VP sFr **24.80**



Art.-Nr. **51.18.87** Bezeichnung **KING REAR R78** Ref VP sFr **23.20**



Art.-Nr. **51.18.88** Bezeichnung Ref VP sFr **24.80**